



Sting S4



Sting S4

OUR HISTORY

In business since 1989

TL-ULTRALIGHT was established in 1989, and is currently among the leading manufacturers of UL and LSA aircraft. The aircraft carrying the TL-ULTRALIGHT brand are being used worldwide. Every single model is individually engineered and is given delicate attention during the entire manufacturing process.

The very first engine-propelled machine that I made was a glider. The next step was a motor tricycle. Both of these products became successful and sold really well. In 1991, TL-ULTRALIGHT began with series production of the first two-seater fixed-wing ultralight aircraft that carried the mark TL for TL 32 Typhoon. The aircraft went on to become a legend in the history of the Czech ultralight aviation. Aviation is a field that waits for no one. It is fast and dynamic. We reacted quickly, developed further, and gave birth to our affordable high-wing Condor aircraft. Than TL 96 Star was born in 1996. The Star was an aerodynamically clean, beautiful, all-composite low-wing monoplane. Thanks to its success I realized that the future in aviation belongs to composite materials. Our aircraft can be found around the world. After the TL Star came the generation of the Sting and Sirius. In 2015 we introduced brand new „air fighter“ Stream to the world.

Today we are one of the biggest and most eminent manufacturers of the UL and LSA aircraft in the world. Our aircraft are recognized and used around the world. This fact makes me very happy and motivates me to continue designing and manufacturing ultralight aircraft of the highest quality. Success and prestige mean that you have to be even more persistent with yourself and not let go. The most modern technologies are at my disposal and are utilized during the production of the aircraft that carry the TL signature. TL-ULTRALIGHT employees are dedicated, reliable and we put our hearts into every single aircraft we exclusively create. And this will never change.

Plus 5
Jiří Tlustý





STING S4

Tuned into perfection.

In 2010, optimal features of the previous Sting version were complemented by new innovations, enhancing performance and giving the aircraft a fresh look. We have consulted pilots and have carefully taken into account their recommendations. That is how the unrivaled Sting S4 came into being – predator in the air, luxurious machine on the ground.

The Sting S4 is a two seater low-wing aircraft made from carbon fiber, powered by engine mounted in the front, seating is side-by-side. The new Sting S4 improvements and aerodynamic modifications make it more than compatible with the Sting RG model which has retractable landing gear. The Sting S4 is currently one of the fastest Czech ultralight aircraft with excellent handling qualities. This sport and cruising aircraft is suitable for all age categories. It ensures excellent enjoyment from flying. Its maximum level flight speed is approx. 285 km/h (177 mph, 154 kts). The speed range of the Sting S4 begins at stalling speed of 63 km/h (39mph, 34 kts) and carries on to the never exceed speed of 305 km/h (190 mph, 166 kts). The Sting S4 captures you and doesn't let go. The most striking feature of the cockpit is the panoramic 360° view.

The outstanding cockpit view, as well as the low noise level contribute to the feeling of comfort, which might surprise you in this category of aircraft. The sense of freedom is enhanced by a considerable aircraft climb speed. The cabin is comprised of a single piece tinted plexiglass canopy which opens upwards and is supported by two piston rods. Cabin heating and cockpit ventilation to prevent fogging were added to enhance pilot's comfort. Other S4 facelift features that were added in 2010 include new canopy handles to ensure easy manipulation and to complete the overall sleek look. The luggage compartment offers up to 25 kg load for the convenience of traveling with luggage. When innovating the Sting, the emphasis was placed primarily on improving flying qualities and the uncompromised comfort for pilot and his passenger.

Sting S4





Sting S4

AERO-TOWING

The Sting S4 is approved for towing gliders, in compliance with Q Amendment of L2 Regulation (Czech Rep.) and LFT – UL Regulation (Germany). During aero-towing flight tests with various types of gliders, the Sting S4 demonstrated excellent towing performance. For example, the take-off distance over a 15m tall obstruction while towing a two-seat glider of 650kg is within 550m. The Sting S4 towing a single-seat glider of 300 kg attains a climb speed of 3,5 m/s. With a two-seater glider of 650 kg, the climb speed is up to 2,2 m/s. High performance, combined with low noise level (58 dB(A)), low fuel consumption and easy piloting, make the Sting S4 the perfect aircraft for aero-towing.

CERTIFIED OPTIONS OF TOWING STING S4:

OPTION	ENGINE	PROPELLER
1	ROTAX 912 ULS	Wezel Flugzeugtechnik MW 180 3BL R
2	ROTAX 912 ULS	Alisport AIV 2-HS
3	ROTAX 912 UL	Wezel Flugzeugtechnik MW 180 3 BL R

AEROTOWING CLIMB SPEED:

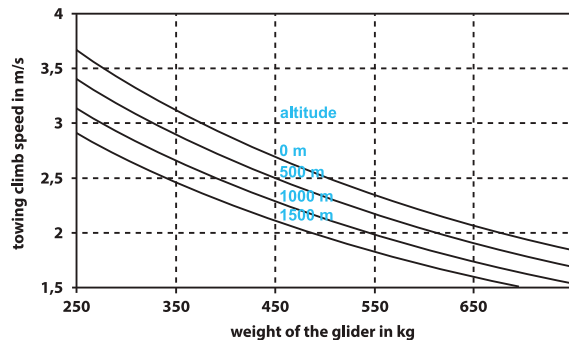

AEROTOWING TECHNICAL DATA:

Maximum strength of towing rope weak link	300 daN +/- 30 daN
Maximum take-off weight of glider	720 kg
Optimal climb speed	110 - 120 km/h
Maximum towing speed	160 km/h

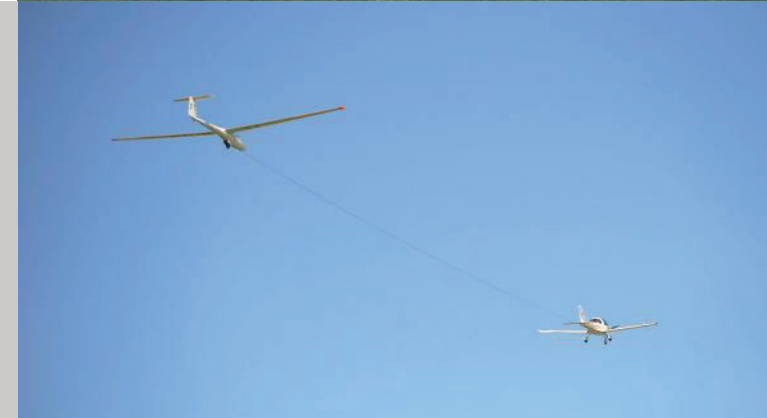

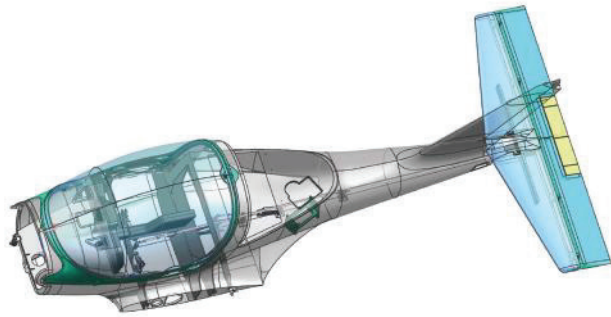

CONSTRUCTION - DESIGN

The Sting S4 has a fully tapered wing, fixed horizontal and vertical stabilizers, split flaps and powerful elevator, rudder and aileron surfaces. Conformal cowling follows the engine contours, directing cooling air precisely to the areas where it is needed. This permits the use of smaller air inlets, presents less frontal and wetted area and reduces drag. The aerodynamic shape of the Sting S4 makes it agile in flight and gives it an impressive 12:1 glide ratio.

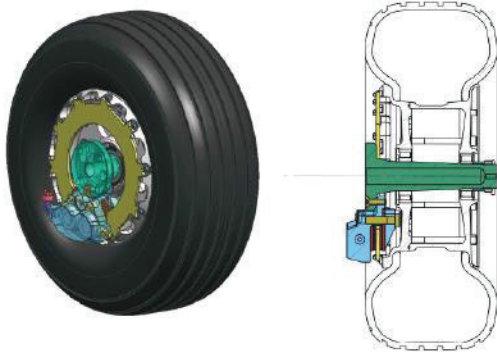

The Sting S4 is built with composite-reinforced epoxy structures. For weight-savings and superior strength, carbon fiber products comprise approximately 85 % of the reinforcing materials. The wing surfaces and fuselage are made from carbon/epoxy sandwich construction cored with closed-cell foam and assembled with epoxy adhesives. Wing spar caps and other heavily loaded components are autoclaved. High-quality molds and care in layup yield a sleek, paintable exterior surface without the need for gel coat, saving 23 kg of non-structural dead weight. Wings, fuselage and empennage are finished in white, two-part epoxy paint. Colorful graphics are available in vinyl, applied over the painted finish. Pilot and his passenger are protected by a carbon-fiber-reinforced cockpit cage with internal rollover protection.



From 2010, the company introduced water jet cutting and other CNC machinery to improve the quality and effectiveness of the serial production. These machines allow to proceed quickly with any new modifications due to their fast and precise model manufacturing.

The Sting S4 design is a product of the TL-ULTRALIGHT development team, with some work done in collaboration with the Czech Technical University in Prague, e.g. design and all-composite aircraft and aircraft components analysis and testing.



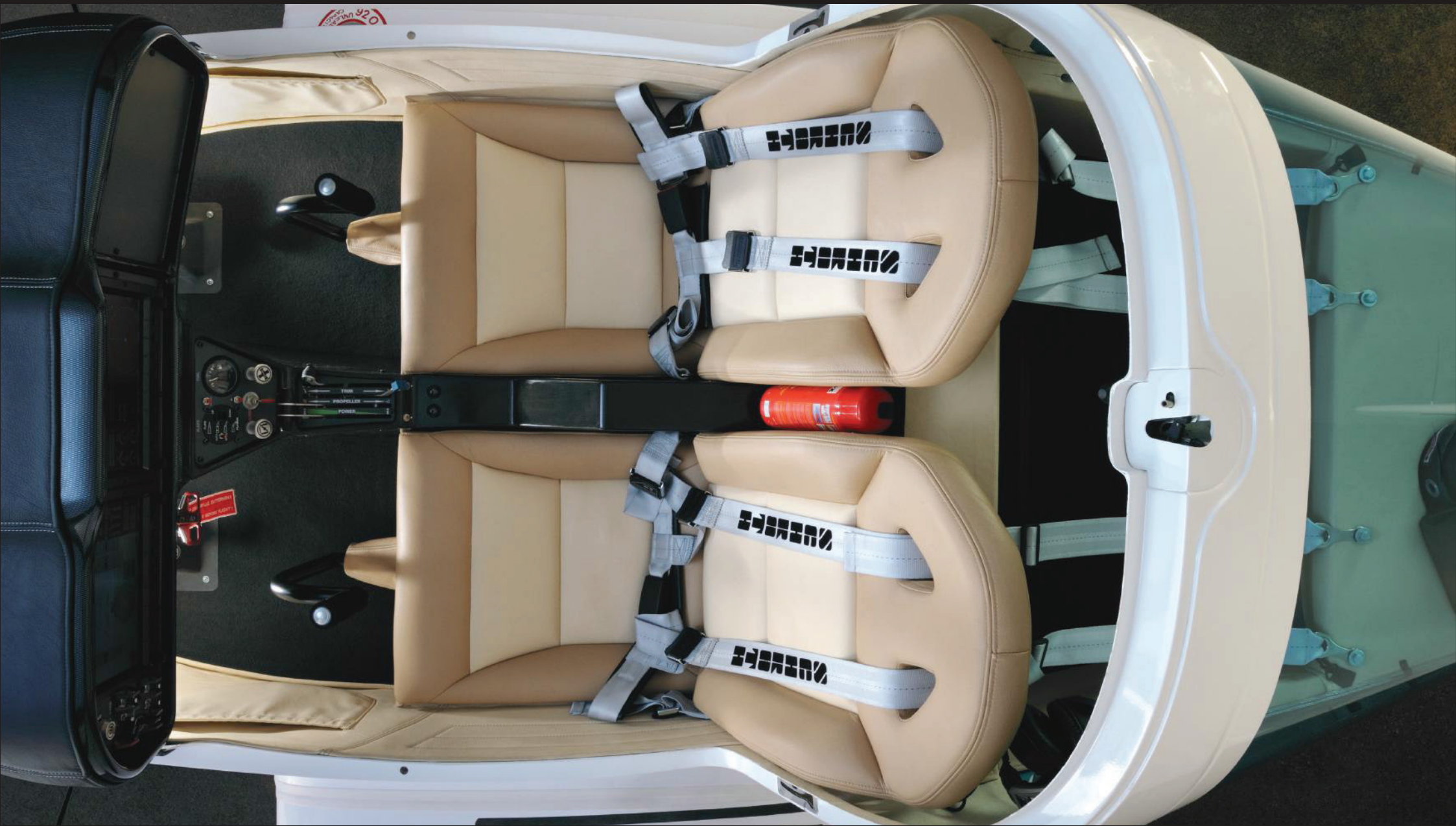

Sting S4

COCKPIT AND SAFETY

The Sting S4 ergonomic cockpit layout promotes proficient flying. Flight controls are strategically placed for ease of access. The layout of the instrument panel facilitates a quick and easy scan. The most striking feature of the cockpit is the panoramic 360° view afforded by the optically blue or tinted canopy. Molded, semi-reclined seats provide lumbar support for pilot and passenger. The inside of the cabin is lined with high quality carpet and map pockets are provided on both sides.

Four point harnesses are standard, as are fresh-air-sourced cabin heating and effective ventilation. The low noise cockpit is well organized and comfortably appointed for hours of flying fun. The whole-plane ballistic parachute system looks very similar to other available products, but on closer inspection there are obvious differences in operation which make the GRS a superior unit. While it is unlikely that you will ever use the GRS in an aircraft, it is comforting to have a parachute system for an unexpected dramatic event. During this critical situation the GRS canopy is drawn away from the aircraft in a short special compact container. The GRS is designed and constructed for the fastest possible opening, which enhances the potential of a rescue of the aircraft and the crew at the lowest possible height.

Firing the system is done mechanically, by manual pulling the activation handle with a force of approximately 9 kg. During firing, there is a minimum rearward impact. Unlike other similar systems, the flame from the rocket tube is not directed back into the trajectory of the rocket, which could cause powerful backfire into aircraft construction. Upon parachute canopy opening above the aircraft at height of approx. 20 meters, the rocket engine continues its own flight on its remaining energy and separates from the main parachute canopy. It then free falls with its own braking inner chute. The main canopy system opens and fully inflates above the aircraft within seconds upon rocket firing. This means that rescue can be successful from as little as 30 to 150 meters above the ground, depending on the position of the aircraft, its speed and trajectory.





Sting S4



ULTRALIGHT

ENGINE AND PROPELLER



1)



2)

ENGINE	PERFORMANCE			TORQUE			max. RPM
	kW	hp	1/min	Nm	t. b	1/min	1/min
912 iS	73,5	100	5800	121	89	5800	5800
912 ULS	73,5	100	5800	128	94	5100	5800
912 UL	59,6	80	5800	103	76	4800	5800
914 UL	84,5	115	5800	144	106	4900	5800

1) The Rotax 912iS is a 4-cylinder, 4-stroke, liquid/air-cooled engine with horizontally opposed cylinders, dry sump with forced lubrication and separate oil tank, automatic hydraulic adjustment of the valve tappets, redundant electric fuel injection, engine management system, electric starter, propeller speed reduction unit, air intake system.

2) The Rotax 912 UL/ULS series engine is a 4-cylinder, 4-stroke, liquid/air-cooled engine with horizontally opposed cylinders, dry sump with forced lubrication and separate oil tank, automatic hydraulic adjustment of the valve tappets, 2 carburetors, mechanical fuel pump, dual electronic ignition, electric starter, propeller speed reduction unit (gearbox), engine mount assembly, air intake system, exhaust system and are available in either 80 hp or 100 hp versions.

The PowerMax is a three-blade tractor in-flight adjustable aircraft propeller. The aluminum alloy hub consists of top and bottom flange with lid. The blade adjustment mechanisms are located inside the hub. Increasing of the blade angle is done by the actuator. For the opposite direction, the blades are adjusted using the resistance of spring located inside the hub. The carbon fiber blade has got a steel root and is mounted onto the hub by a pair of axial bearings. Each propeller blade is designed with a special leading edge protection against accidental impact of small particles such as tiny rocks. The actuator is located outside the hub, above the engine reduction unit, and controls the blade adjustment by a hollow axis of the reduction unit and the propeller.





Sport AIRCRAFT



Sting S4

AVIONICS

Standard fitting of the Sting S4 comes with the most modern glass cockpit of the GARMIN brand.

The Sting S4 is equipped with ultramodern glass cockpit.

If you still desire more, we can deliver. Upon your request, we can equip your new Sting S4 with classic analog devices or with any other form of avionics. This of course also applies to GPS, radios and many other devices. Whatever it may be, we can put it together for you!

GARMIN G3X Touch

Pilots of larger aircraft know GARMIN well. Recently, a new system – the G3X Touch, suitable for use in ultralight aircraft has been introduced by GARMIN. That is why one of the best most reliable glass cockpit solutions of the highest quality is being currently offered to you by us.

Their very bright high resolution touchscreen displays that are easily readable even in direct sunlight ensure that all necessary data are only a few touches away. Each easy-to-read display features a screen with infrared touchscreen technology with a large touchpoint that ensures precise inputs and minimizes inadvertent touches – even with gloves. 3D outside terrain viewing, various mapping options and surrounding traffic information – all of these and more are being delivered to you in the GARMIN G3X Touch!

Additionally, the G3X interfaces with GARMIN's GMC 305 autopilot, allowing pilots to control the autopilot via touch screen. The G3X can also incorporate GARMIN's transponder, communications radio and intercom, including 3D radio features that makes sounds appear in different areas of the headset. When incorporated with the communications system, the G3X also includes frequency identification on the screen. GARMIN's portable Virb camera can also be incorporated to show video in a window on the PFD screen.



VINYL GRAPHIC DESIGNS

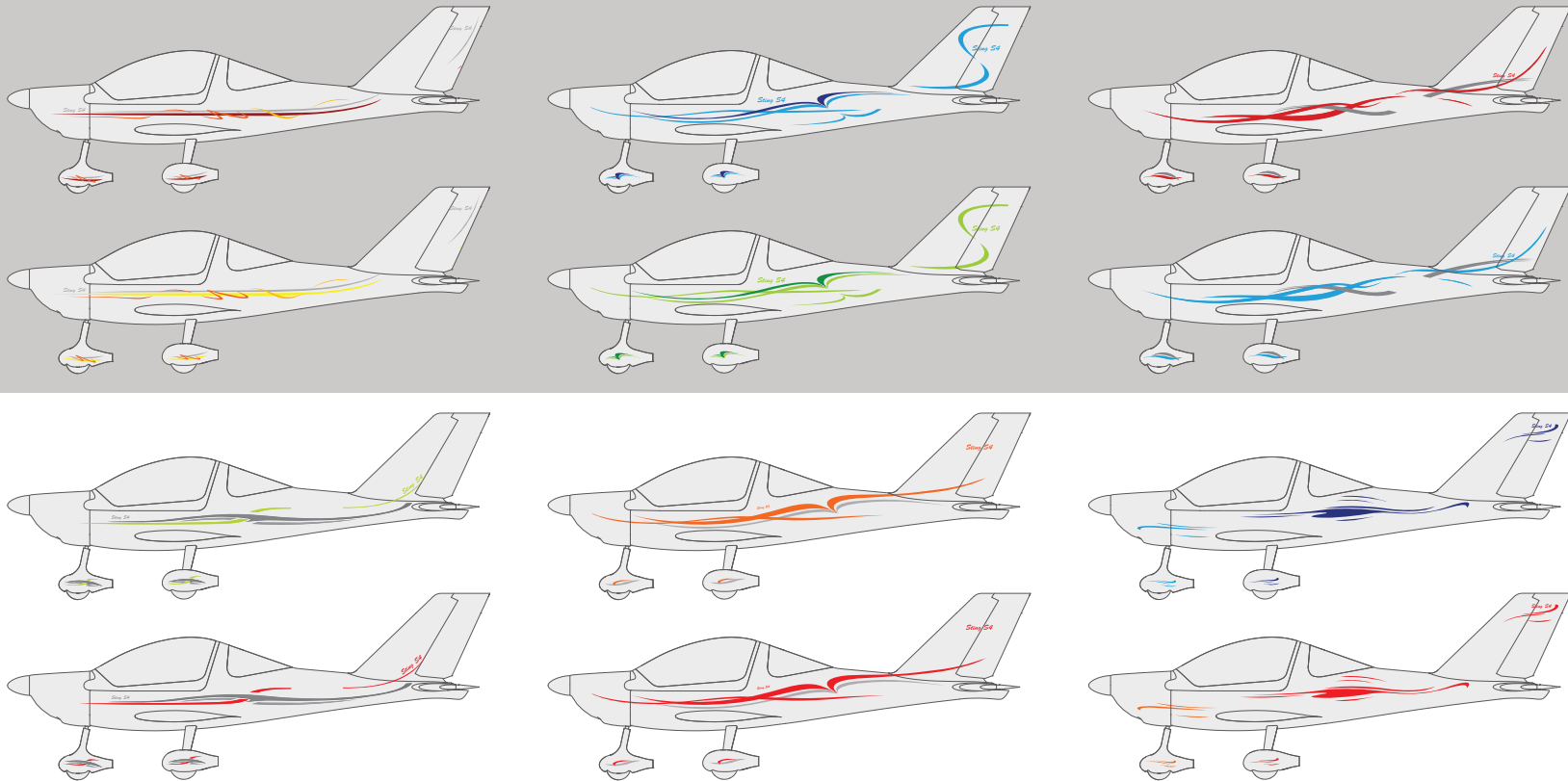

Sting S4

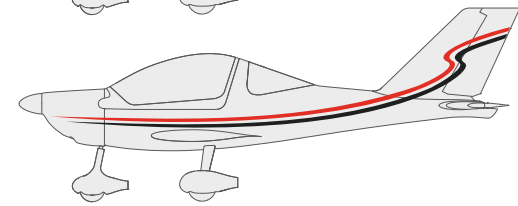
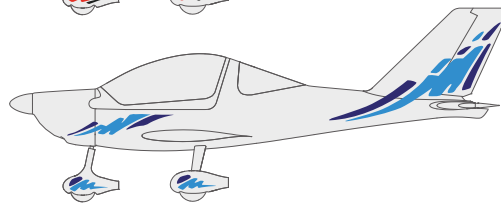
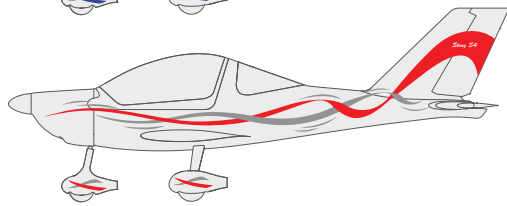
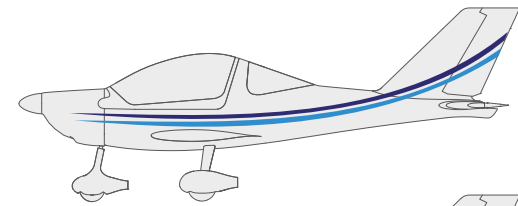
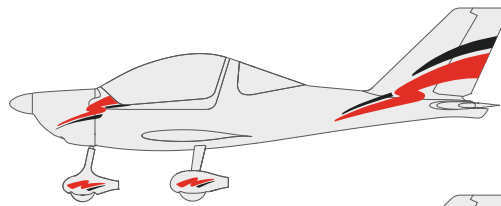
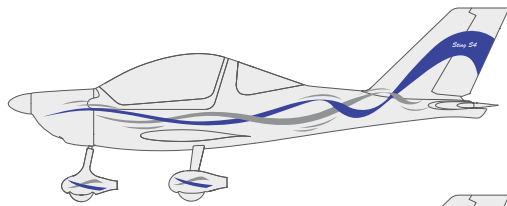
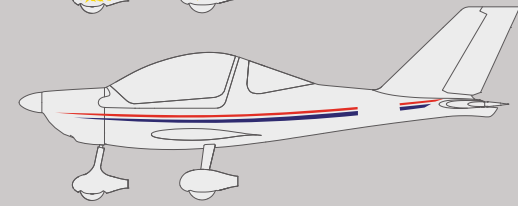
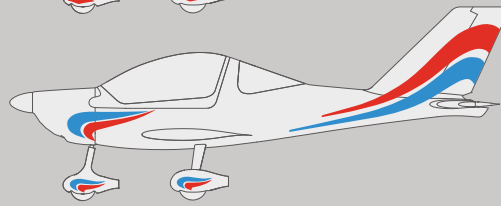
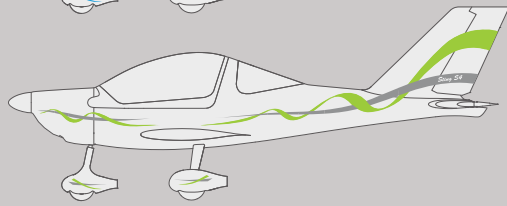
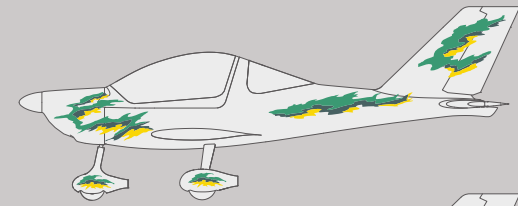
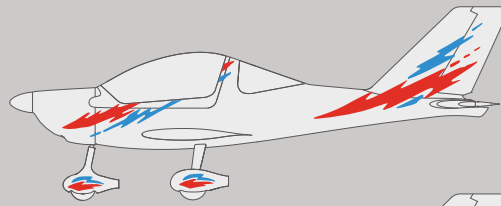
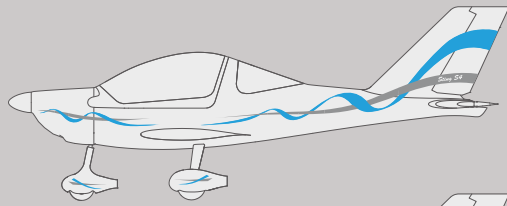
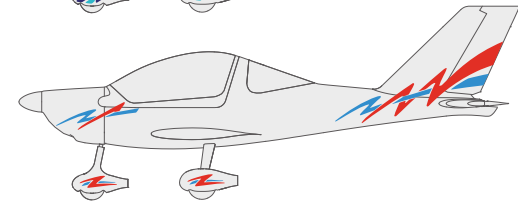
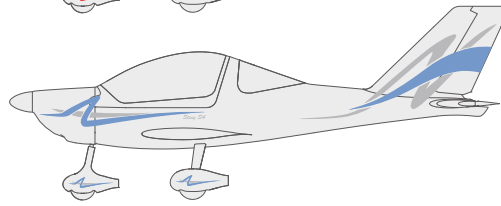
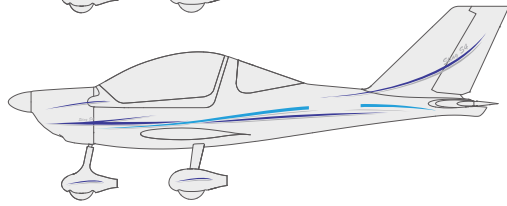
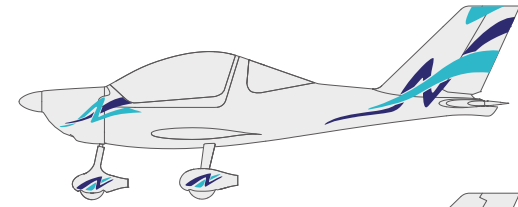
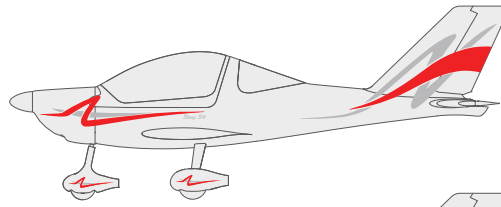
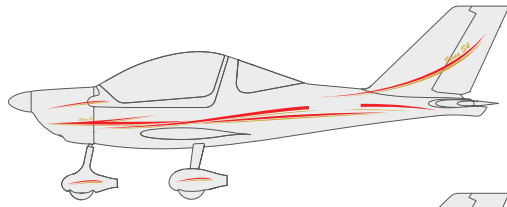



Sting S4

PRODUCTION / SERVICE

The TL-ULTRALIGHT company is located in its own buildings, offices and hangars at Hradec Kralove airport in the Czech Republic. Within these self contained facilities the entire design, production, testing and quality control of all aircraft are carried out.

An average production rate of 9 to 10 aircraft per month leaves final assembly line for the TL flight testing hangar. Repairs and services are provided for all previously completed aircraft. The staff consists of more than hundred employees focused on production. An additional team of more than ten employees care for sales, material supply, production management and quality control. At the Hradec Kralove airport all test flights, demonstration flights, training, warranty and after warranty repairs are done by highly qualified aircraft engineers. The TL production and quality control allow to track and backtrail any production stage of an aircraft and is sophisticated logistics system which complies with ASTM standards. Beyond this, each and every aircraft is personally test flown by the owner, Mr. Jiri Tlustý.

Aircraft shipped overseas are being packed and loaded into containers to over thirty dealers who distribute TL products. Currently, aircraft are delivered to the United States, the European Union, and other countries in the World.





TECHNICAL DATA

Engine	912 iS	Length	6,20 m
Propeller	PowerMax	Wing span	9,12 m
V _{NE}	305 km/h	Height	2,05 m
Cruising speed	180 - 250 km/h	Max. crew weight	180 kg
Empty weight	297 kg	Min. crew weight	60 kg
Max. take-off weight	472,5 kg	Max. lugagge weight	25 kg
Flying range	840 km (1370 km)	Fuel	77 l (+44 wing tanks)

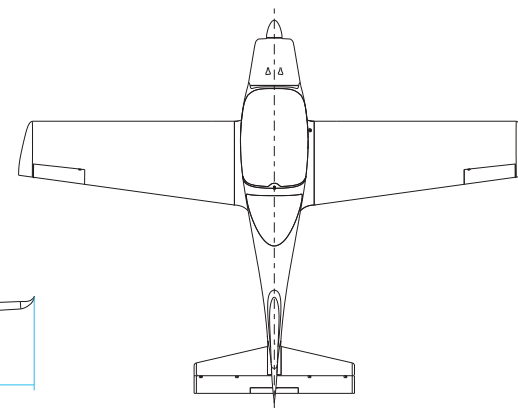
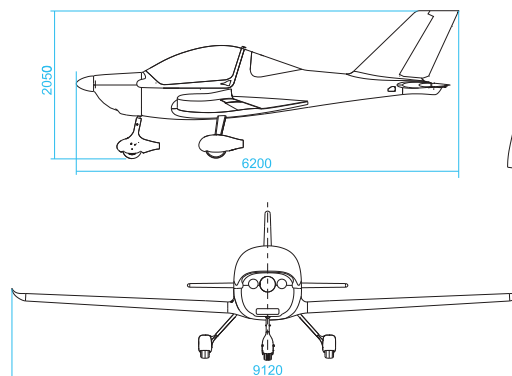

Sting S4

